



6390 Philips Highway
 Jacksonville, FL 32216
 Phone (904) 737-7144

SPECIFICATION DATA SHEET

MODEL No. 332

VENT TOP with WIND BAND

Date: 05/13/21 rev.

Drawn by: J.E.P.

DIMENSIONAL DATA

"A"	"B"	"C"	"D"
3"	5"	6-1/2"	4"
4"	6"	7-1/2"	4"
5"	7"	9"	4"
6"	8"	10"	4-1/2"
7"	9"	11-1/2"	4-1/2"
8"	10"	13"	4-1/2"
9"	11"	14"	4-1/2"
10"	12"	16"	5"
12"	14"	18"	6-1/2"
14"	17"	20"	6-1/2"
16"	19"	23"	6-1/2"
18"	21"	27"	6-1/2"

FABRICATION DATA

MATERIAL: HOT DIPPED GALVANIZED STEEL SHEET OF LOCK FORMING QUALITY PER ASTM-A653 CS TYPE B.

GAUGES: 3" THROUGH 7"; 26 GAUGE
 8" THROUGH 18"; 24 GAUGE

FEATURES

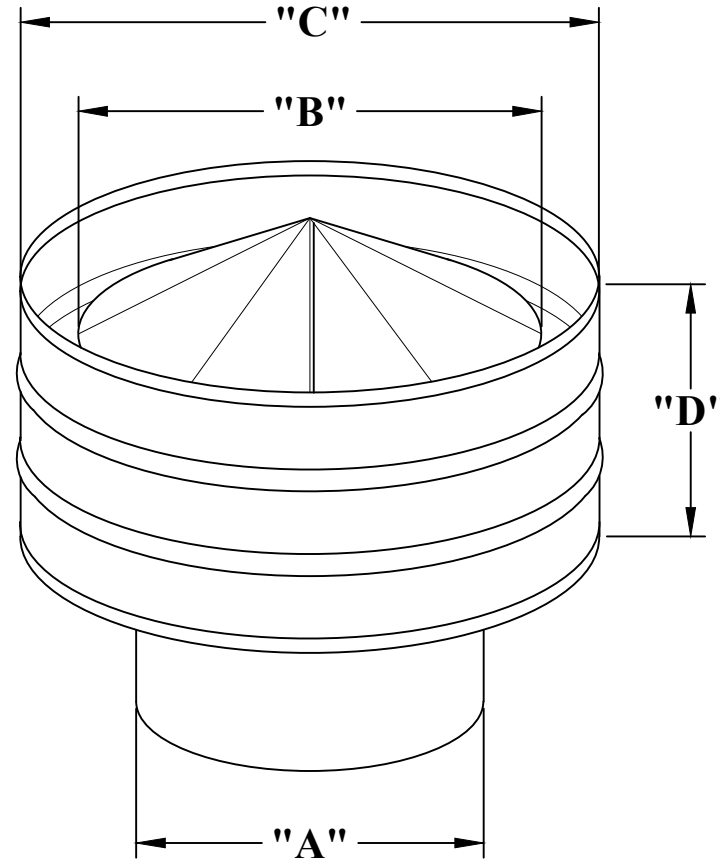

OPTIONS

WITH 1/2" HARDWARE CLOTH SCREEN.

SPECIAL NOTES

ORDER BY "A" DIMENSION.

RECOMMENDED INSTALLATION:

SECURE VENT TOP USING #10 SCREWS ON 6" CENTERS