



6390 Philips Highway
Jacksonville, FL 32216
Phone (904) 737-7144

SPECIFICATION DATA SHEET

MODEL No. 245
VERTICAL 45 ° WALLSTACK ELBOW

Date: 07/23/03

Drawn by: M.D.C.

DIMENSIONAL DATA

SIZES AVAILABLE:

3-1/4" x 10"

3-1/4" x 12"

3-1/4" x 14"

1-1/2" x 1-1/2" THROAT STANDARD

FABRICATION DATA

MATERIAL:

FABRICATED FROM HOT-DIPPED GALVANIZED
STEEL SHEET OF LOCK FORMING QUALITY
PER ASTM-A653 CS TYPE B.

28 GAUGE STANDARD. 26 AND 24 GAUGE
AVAILABLE.

TRANSVERSE CONNECTIONS

MALE END: BUTTON HOLES

FEMALE END: STACKING CLIPS

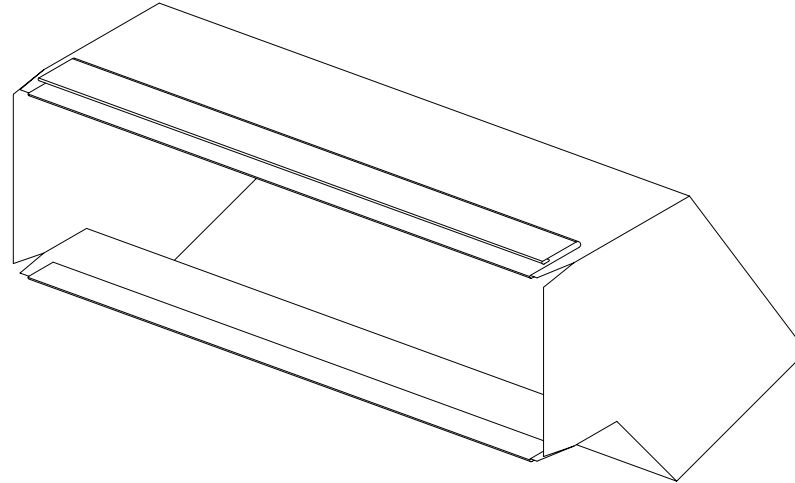

OPTIONS

SPECIAL NOTES